



## Room thermostat with independent DHW control

**RDD100.1  
DHW**

for heating systems

- 
- Room temperature control
  - 2-position control with ON/OFF control output
  - Independent On/Off control of DHW
  - Comfort, Economy and Protection mode
  - Adjustable commissioning and control parameters
  - Battery-powered DC 3 V (2 x 1.5 V AAA)

### Use

---

The RDD100.1DHW is used to control the room temperature in heating systems with independent control of DHW.

Typical applications:

- Apartments

For the control of the following plant components and of DHW:

- Thermal valves or zone valves
- Gas or oil boilers
- Fans
- Pumps
- Heat exchanger
- Continuous-flow water heater
- Small water heating systems

## Functions

- Room temperature control via built-in temperature sensor
- Selection of operating mode with operating mode touchkey
- Display of current room temperature or setpoint in °C or °F
- Touchkey lock (manually)
- Setpoint lock
- Reloading factory settings for commissioning and control parameters
- Independent DHW

## Temperature control

The unit acquires the room temperature with its built-in sensor and maintains the setpoint by delivering control commands. The switching differential is 1 K.

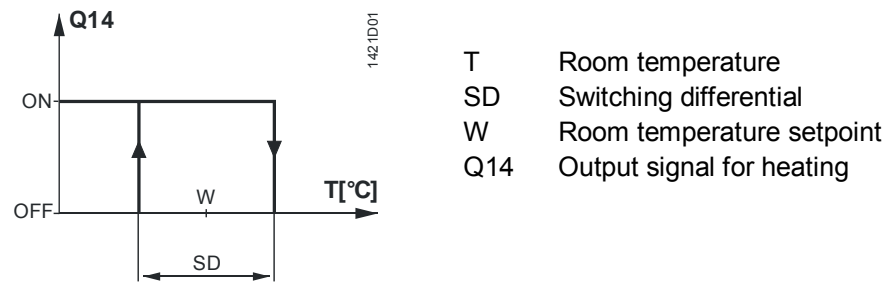

## Type summary

Product No.	Stock No.	Features
RDD100.1DHW	<b>S55770-T277</b>	DHW room thermostat Battery-powered DC 3 V









## Ordering

- When ordering, please indicate product No. / stock No. and description.
- Example:

Product No.	Stock No.	Description
RDD100.1DHW	<b>S55770-T277</b>	DHW room thermostat

Valve actuators must be ordered separately!

## Equipment combinations

Description		Product No.	Data Sheet
Electromotoric actuator		<b>SFA21..</b>	4863
Electrothermal actuator (for radiator valves)		<b>STA23..</b>	4884
Electrothermal actuator (for small valves 2.5 mm)		<b>STP23..</b>	4884
Electromotoric actuator for zone valves VVI46..		<b>SUA21..</b>	4830
Damper actuator		<b>GDB..</b>	4634
Damper actuator		<b>GSD..</b>	4603
Damper actuator		<b>GQD..</b>	4604
Rotary damper actuator		<b>GXD..</b>	4622

## Mechanical design

The room thermostat consists of 2 parts:

- Plastic housing which accommodates the electronics, the operating elements and the room temperature sensor
- Mounting plate with screw terminals

The housing engages in the mounting plate and is secured with a screw.



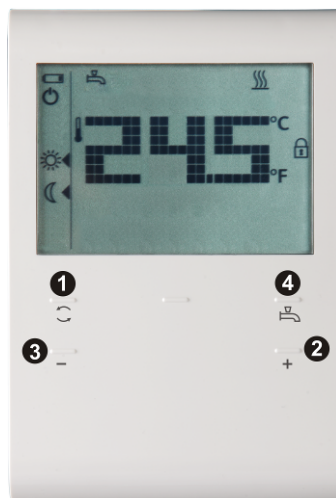



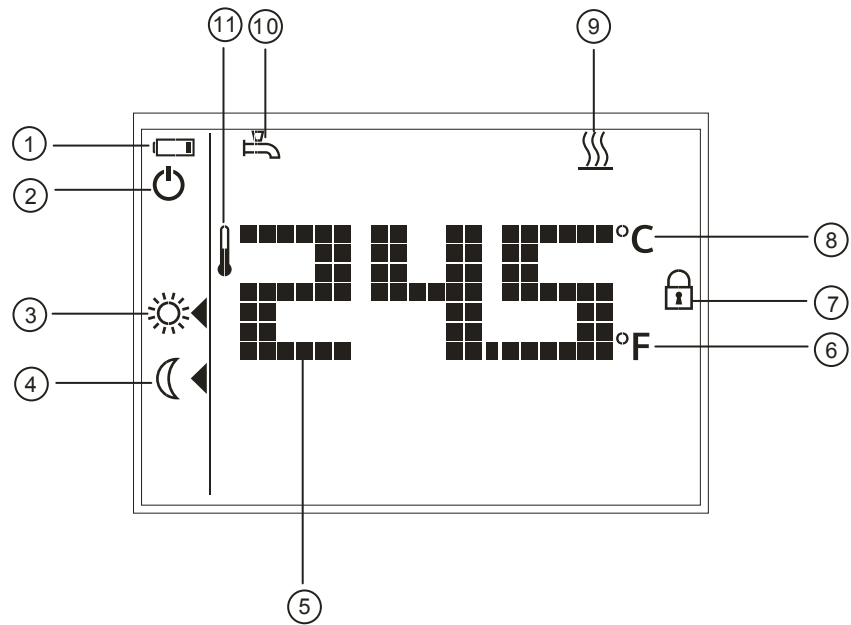

## Operation and settings



- 1) Operating mode touchkey \
- 2) Touchkey for increasing a value
- 3) Touchkey for decreasing a value
- 4) DHW switch On/Off touchkey

## Display



#	Symbol	Description	#	Symbol	Description
1		Indicating that batteries need to be replaced	6	°F	Room temperature in degrees Fahrenheit
2		Protection mode (protection mode symbol can be enabled via parameter settings)	7		Touchkey lock activated
3		Comfort mode	8	°C	Room temperature in degrees Celsius
4		Economy mode	9		Heating On
5	24.5	Display of room temperature, setpoint, etc.	10		DHW On
			11		Current room temperature

## Mounting and installation notes

---

Do not mount the thermostat in niches or bookshelves, not behind curtains, not above or near heat sources, and not exposed to direct solar radiation. Mount about 1.5 m above the floor.

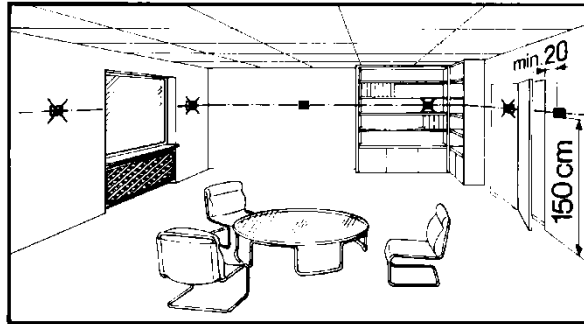

### Mounting



- Mount the thermostat in a clean and dry location without direct air flow from a heating/cooling equipment, and not exposed to drip or splash water

### Wiring



See the Mounting Instructions M1429 enclosed with the thermostat.

- Ensure that wiring, protection and earthing comply with local regulations
- Correctly size the cables to the thermostat and the valve actuators
- Use only valve actuators rated for AC 24...230 V

#### **Warning!**

**No internal line protection for supply lines to external consumers.**

Risk of fire and injury due to short-circuits!



- Adapt the line diameters as per local regulations to the rated value of the installed overcurrent protection device.
- The AC 230 V mains supply line must have a circuit breaker with a rated current of no more than 10 A
- Disconnect from power supply before removing the unit from its mounting plate

## Commissioning notes

---

### Commissioning

After power is applied, the thermostat carries out a reset during which all LCD segments flash, indicating that reset was made correctly. After the reset, the thermostat is ready for commissioning by qualified HVAC personnel.

The control parameters of the thermostat can be set to ensure optimum performance of the entire system. Please refer to Operating Instructions CB1B1421, section "Do you want to change parameters?".

### Sensor calibration

If the temperature on the display does not agree with the room temperature effectively measured, the temperature sensor can be recalibrated. For that purpose, adjust parameter P04.

### Setpoint and setpoint lock

We recommend to review the setpoint range and setpoint lock (for public areas) using parameters P05...P08 and change them as needed to achieve maximum comfort and energy savings.

### Touchpad scanning rate

Since the thermostat uses touch technology and to minimize battery power consumption, a parameter P21 (adjustable from 0.25 to 1.5 seconds) is

implemented for the user to adjust. This function is only valid for the battery-powered version and the default value is 1 second.

This means that when, for a certain time, the user does not touch the touchpad, the unit operates in power saving mode and the touchpad is running at a scanning rate of 1 second.

(From the calculation – assuming 4 operations per day on the thermostat, the estimated 1-second scanning rate results in a battery life of 1 year. If the user increases the scanning rate, the batteries' life is extended.)

### Change of batteries

If the battery symbol  appears, the batteries are almost exhausted and should be replaced. Use alkaline batteries type AAA.

## Operating notes

---

The RDD100.1DHW provides Comfort, Economy and Protection mode. The difference between Comfort and Economy mode is only the room temperature setpoint. The changeover between Comfort, Economy and Protection mode is made by pressing touchkey .

### Comfort mode

When Comfort mode is activated, symbol  appears on the display. The setpoint (20 °C) can be readjusted by pressing touchkeys + and –.

### Economy mode

When Economy mode is activated, symbol  appears on the display. The setpoint (16 °C) can be readjusted by pressing touchkeys + and –.

### Protection mode

If the temperature falls below 5 °C, the unit automatically activates the heating output. The symbol  appears only, if the icon is enabled via parameter settings.

### DHW

When this DHW function is activated, symbol  appears on LCD.

## Maintenance notes

---

The thermostats are maintenance-free.

## Disposal

---



The device is considered an electronic device for disposal in terms of the European Directive 2012/19/EU and may not be disposed of as domestic garbage.

- Dispose of the device through channels provided for this purpose.
- Comply with all local and currently applicable laws and regulations.
- Dispose of empty batteries in designated collection points.



### WARNING

**Risk of explosion due to fire or short-circuit, even if the batteries are empty**

Risk of injuries from by flying parts

- Do not allow the batteries to come into contact with water.
- Do not charge the batteries.
- Do not damage or destroy the batteries.
- Do not heat the batteries to more than 85 °C.



### WARNING

**Electrolyte leakage**

Chemical burns

- Only grasp damaged batteries using suitable protective gloves.
- If electrolyte comes into contact with eyes, immediately rinse eyes with plenty of water. Consult a doctor.

Observe the following:

- Only replace batteries with batteries of the same type and from the same manufacturer.
- Observe the polarities (+/-).
- The batteries must be new and free from damage.
- Do not mixed new batteries with used batteries.
- Store, transport, and dispose of the batteries in accordance with local regulations, guidelines, and laws.  
Also observe information from the battery manufacturer.

## Technical data



### Power supply

Operating voltage  
 • RDD100.1DHW DC 3 V (2 x 1.5 V alkaline batteries AAA)

For battery life (RDD100.1DHW), see below (alkaline batteries type AAA).  
 Battery life calculation is based on the touchpad scanning rate during idle time  
 (assuming a user presses 4 touchkeys per day):

Scanning rate 0.25 s	193 days battery life
Scanning rate 0.50 s	273 days battery life
Scanning rate 1.00 s	345 days battery life
Scanning rate 1.50 s	378 days battery life

### Control inputs

Control input Q11-Nx (Com)	(AC 24...230 V)	Max. 5(2) A	Min. 8 mA
Control input Q21-Nx (Com)	(AC 24...230 V)	Max. 5(2) A	Min. 8 mA

### Control outputs

Heating valve or wall-hung boiler

Control output Q12-Nx (NC contact)	(AC 24...230 V)	Max. 5(2) A	Min. 8 mA
Control output Q14-Nx (NO contact)	(AC 24...230 V)	Max. 5(2) A	Min. 8 mA



### DHW heating equipment

Control output Q22-Nx (NC contact)	(AC 24...230 V)	Max. 5(2) A	Min. 8 mA
Control output Q24-Nx (NO contact)	(AC 24...230 V)	Max. 5(2) A	Min. 8 mA

### No internal fuse.

External preliminary protection with max. C 10 A circuit breaker in the supply lines  
 required under all circumstances.

### External protection for incoming cable

Circuit breaker	Max. 10 A
Circuit breaker tripping characteristic	Type B, C or D to EN 60898 and EN 60947

### Function data

Switching differential SD	1 K
Comfort mode	20 °C (5...35 °C)
Economy mode	16 °C (5...35 °C)

### Built-in room temperature sensor

Setpoint setting range	5...35 °C (Comfort/Economy mode)
Accuracy at 25 °C	< ±0.5 K
Temperature calibration range	±3.0 K

### Resolution of settings and displays

Setpoints	0.5 °C
Temperature value displays	0.5 °C

### Environmental conditions

Operation	As per IEC 60721-3-3
Climatic conditions	Class 3K5
Temperature	0...50 °C
Humidity	<95% r.h.
Transport	As per IEC 60721-3-2
Climatic conditions	Class 2K3
Temperature	-25...60 °C
Humidity	<95% r.h.
Mechanical conditions	Class 2M2

Storage	As per IEC 60721-3-1
Climatic conditions	Class 1K3
Temperature	-25...60 °C
Humidity	<95% r.h.



Norms and standards	EU Conformity (CE)	A6V11399487 <sup>*)</sup>
	RCM conformity	A6V11399489 <sup>*)</sup>
	Safety class	II as per EN 60730-1, EN 60730-2-9
	Pollution class	II as per EN 60730-1
	Degree of protection of housing	IP30 as per EN 60529
Environmental compatibility	The product environmental declaration CE1E1420xx <sup>*)</sup> contains data on environmentally compatible product design and assessments (RoHS compliance, materials composition, packaging, environmental benefit, disposal).	
Eco design and labelling directives	Based on EU Regulation 813/2013 (Eco design directive) and 811/2013 (Labelling directive) concerning space heaters, combination heaters, the following classes apply:	
	Application with On/Off operation of a heater	Class I value 1.0%
General	Connection terminals for	Solid wires or prepared stranded wires 2 x 1.5 mm <sup>2</sup> or 1 x 2.5 mm <sup>2</sup> (Min. 0.5 mm <sup>2</sup> )
	Weight	0.167 kg
	Color of housing front	RAL9003

<sup>\*)</sup> The documents can be downloaded from <http://siemens.com/bt/download>.

## Connection diagrams

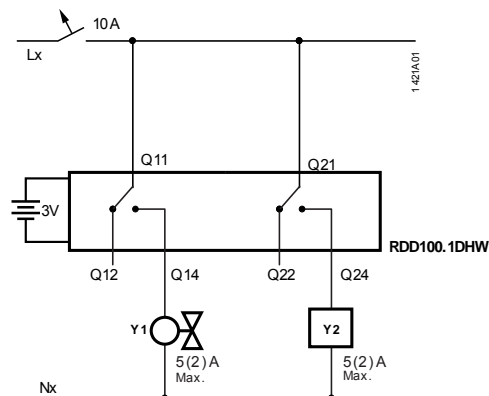

Legend	Lx	Live, AC 24...230 V
	Nx	Neutral conductor, AC 24...230 V
	Y1	Heating valve or wall-hung boiler
	Y2	DHW heating equipment

## Appication examples

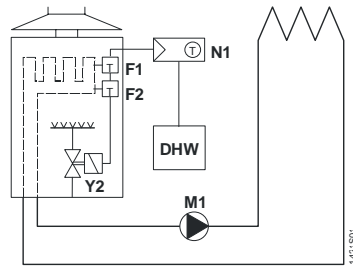

Room thermostat with direct control of a gas-fired wall-hung boiler with independent control of DHW

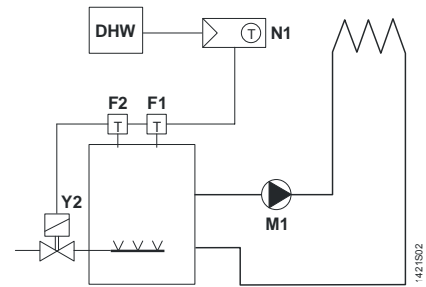

Room thermostat with direct control of a gas-fired floor-standing boiler with independent control of DHW

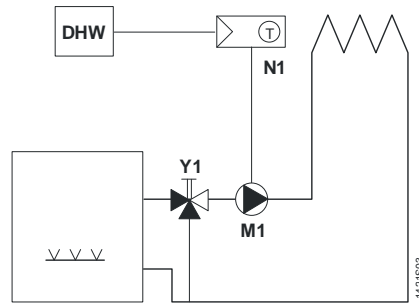

Room thermostat with direct control of a heating circuit pump (precontrol by manual mixing valve) with independent control of DHW

- F1 Thermal reset limit thermostat
- F2 Safety limit thermostat
- M1 Circulating pump
- N1 RDD100.1DHW room thermostat
- Y1 Mixing 3-port valve with manual adjustment
- Y2 Magnetic valve
- DHW DHW heating equipment

## Dimensions

All dimensions in mm

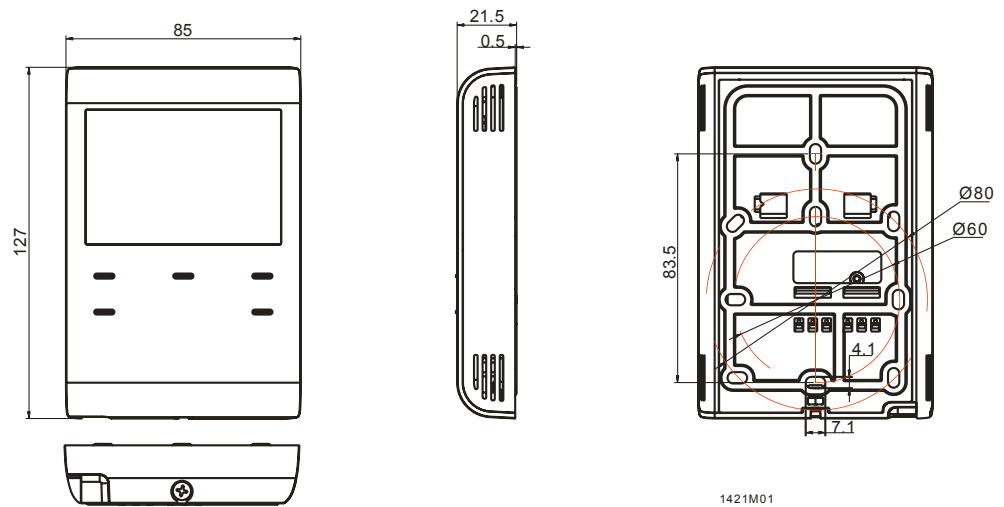

## Remarks

---

### **Heating:**

Because of the unavoidable self heating effects of the electrical current, any loads of more than 3 Amperes connected to the unit can influence the control behavior and temperature accuracy in a negative way.

Issued by  
Siemens Switzerland Ltd.  
Building Technologies Division  
International Headquarters  
Theilerstrasse 1a  
CH-6300 Zug  
Tel. +41 58 724 2424  
[www.siemens.com/buildingtechnologies](http://www.siemens.com/buildingtechnologies)

© Siemens Switzerland Ltd, 2013 - 2018  
Technical specifications and availability subject to change without notice.